

**VALENCIA COLLEGE**

**Department of Electrical and Computer Engineering Technology (ECET)  
Division of Engineering, Computer Programming, and Technology (ECPT)**

**EET 4910**

**Senior Design Proposal**

**Personal Automated Lawn Mower  
(P.A.L.M.)**

**Submitted by**

**Brian Darling and Gabriel De La Torre**

**Supervised by**

**Prof. Notash**

**April 16, 2021**

# Abstract

Lawn maintenance can be time consuming and exhausting, especially for a highly active family. Not to mention the hot summer heat can be brutal on the elderly and those with health conditions.

A fully automated lawn mower that can maintain the yard several times a week can really help time restricted families make more time for other things they need to do, reduce weeds growing in the yard, and save households money over time from lawn maintenance services.

This mower will be a fully automated system that will cut the grass on autopilot with the users preferred cutting consistency. To easily and efficiently control the cutting area, there will be an underground wire emitting a signal. This will create an "invisible fence" to help the mower stay within its cutting boundaries.

Adding in safety features like obstruction detection, mower flip sensors, and ways to check if the blade and wheels are stuck will prevent any injuries and help prolong equipment life.

With the addition of solar panels and rechargeable batteries, the mower can also reduce the household's carbon footprint and noise output. The mower will self dock at a charging station or have solar panels on the unit itself and be self charging.

# Acknowledgements

We would like to give thanks to Prof. Notash for helping us with this project every step of the way. His clear and precise guidance allowed us to complete a project that we could be proud of as effectively as possible. This includes his constant feedback during the weekly meetings, as well as his timely response to any separate questions sent to directly.

We would also like to give thanks to Valencia College and all of its staff for helping us get this far. Thanks to all the great professors we had we were able to learn the skills necessary to complete this project and to take one step closer to our dream of becoming true professional engineers.

# Table of Contents

<b>Abstract</b> .....	<i>iii</i>
<b>Acknowledgements</b> .....	<i>iv</i>
<b>List of Figures</b> .....	<i>v</i>
<b>List of Tables</b> .....	<i>vi</i>
<b>Chapter 1 Introduction</b> .....	<b>1</b>
1.1 Introduction .....	2
1.1.1 Motivation .....	2
1.1.2 Objective and Features .....	2
1.2 Similar and Existing Products .....	3
1.2.1 MowBot .....	3
1.2.2 Husqvarna Mowers .....	4
1.2.3 MowRo .....	4
<b>Chapter 2 Proposed Work</b> .....	<b>5</b>
2.1 Principals .....	6
2.1.1 Block Diagram .....	6
2.1.2 Engineering Requirements and Specifications .....	7
2.1.3 Power Budget .....	14
2.2 Proposal Product .....	16
2.2.1 Mower .....	16
2.2.2 Docking Station .....	19
2.2.3 Remote Control .....	21
<b>Chapter 3 Non-Technical Issues</b> .....	<b>22</b>
3.1 Budget and Timeline .....	23
3.1.1 Budget .....	23
3.1.2 Timeline .....	23
3.2 Environmental Aspects .....	23
3.3 Health and Safety .....	24
3.4 Ethical Aspects .....	24
3.5 Social Aspects .....	25
3.6 Sustainability .....	25
<b>Chapter 4 Conclusion</b> .....	<b>26</b>
4.1 Summary & Conclusion .....	27
4.2 Suggestions for Future Work .....	28
<b>References</b> .....	<b>29</b>
<b>Appendix A: Equations</b> .....	<b>30</b>

# List of Figures

Figure 1.1	Husqvarna AutoMower .....	4
Figure 1.2	MowRo and Docking Station .....	4
Figure 2.1	P.A.L.M. Block Diagram .....	7
Figure 2.2	Mower Block Diagram .....	16
Figure 2.3	Mower Chassis Assembly Bottom .....	17
Figure 2.4	Mower Chassis Assembly Middle .....	17
Figure 2.5	Mower Chassis Assembly Top .....	18
Figure 2.6	Docking Station Flow Chart .....	20
Figure 3.1	Timeline .....	23

# List of Tables

Table 2.1	Design Engineering Requirements (DER) .....	8
Table 2.2	Design Engineering Specifications (DES).....	9
Table 2.3	Power Budget .....	15
Table 3.1	Budget .....	23

# Chapter 1

## Introduction

### Summary

In this chapter, we present the basic principles of the P.A.L.M., a fully automatic lawn mower designed to remove the effort of mowing the lawn as well as the high cost of continuous payment for lawn mowing services. This chapter will discuss the features used to create this device as well as the benefits of owning it.

### 1.1 Introduction

#### 1.1.1 Motivation

#### 1.1.2 Objective and Features

### 1.2 Similar and Existing Products

#### 1.2.1 MowBot

#### 1.2.2 Husqvarna Mowers

#### 1.2.3 MowRo

## **1.1 Introduction**

Mowing the lawn has always been one of the many painstaking tasks that are required to maintain the look of one's home. The two options have always been to either put in the work and mow it yourself or to pay someone to do it for you. The former requires a significant amount of work and the latter can get very expensive overtime.

The P.A.L.M. is a fully automated lawn mower that can be set up to mow the lawn with practically no input from the user besides the initial setup. Due to its abilities to learn the shape of one's lawn and to automatically recharge its own battery, this mower can provide continuous maintenance of the user's lawn for an extended period of time. This would eliminate the need to continuously waste money on lawn maintenance and the inconvenience of having to cut it yourself.

### **1.1.1 Motivation**

The inspiration for this idea came from the fact that there are many people who struggle to maintain their lawn because they either cannot afford to pay to get it cut or because they are physically incapable of cutting it. This can include people with disabilities, senior citizens, or even those that simply do not have the time to constantly mow their lawn. Having a fully hands-off automatic mower would solve the economic issue by only requiring one payment that would pay for itself over time and the physical issue by removing all effort from mowing the lawn.

### **1.1.2 Objectives and Features**

The P.A.L.M. requires several features to help it provide the automatic mowing experience. It needs to be able to maneuver the lawn automatically, to recharge its batteries on its own, and to avoid any obstacles it might find while it is cutting. Moreover, the device also features a manual mode where the user can control the mower using a remote controller if they wish to cut the grass themselves or add extra cutting details.



### **1.1.2.1 Automatic Lawn Maneuvering**

The automatic maneuvering will be achieved by utilizing GPS navigation to determine the outer perimeter of the lawn and using this shape to automatically create a path within the designated cutting area to travel.

### **1.1.2.2 Automatic Recharging**

The mower will have a continuous charging system by using its integrated solar panel that will be mounted on top of the mower. This will help increase the battery charge as the system is charging while in use.

### **1.1.2.3 Manual Control Mode**

The manual control will be achieved by selecting the manual option on the controller and then simply steering the mower as if it was a remote control car. This would give the user the option to cut outside of the setup barrier if the need should arise.

### **1.1.2.4 Obstacle Detection**

The obstacle detection will be achieved by placing sensors on the front of the mower. Whenever the device detects an object in its path, it will inform the mower that it needs to change its path in order to avoid an obstacle. The mower will simply keep turning and try to move forward until it no longer bumps into the obstacle and then continue cutting on its programmed path.

## **1.2 Similar and Existing Products**

In our research we found similar products to our project that were lacking some of the more useful features that we are planning to implement. Our device sees to improve on existing designs to create a more efficient and self-sustaining system.

### **1.2.1 MowBot**

The MowBot is a lawn service that uses mowing robots to cut and maintain a yard [1]. It uses a wire to form a boundary around the lawn that is installed by the service technician.

In order to cut the lawn, the robot moves in an irregular pattern which given enough time would allow it to mow most of the grass while staying within the boundary wires.

### 1.2.2 Husqvarna Mowers

The Husqvarna Mowers also use wires to establish boundaries while utilizing GPS modules to help guide its movement patterns [2]. This device can also communicate with the user's phone to send important notifications.



Figure 1.1 Husqvarna AutoMower [2]

### 1.2.3 MowRo

The MowRo also uses boundary wires for guidance while relying on an algorithm to control its movement. This device also includes safety features that encapsulate the blades in order to prevent accidents and can detect rain in order to prevent water damage to the device.



Figure 1.2 MowRo and Docking Station [3]

# Chapter 2

## Proposed Work

### Summary

In this chapter, we go over how the mower will function, what functions we will need for the mower to work properly, as well as how much power the product will use. We will also review similar products that are currently on the market and briefly describe how they work.

## 2.1 Principles

### 2.1.1 Block Diagram

### 2.1.2 Engineering Requirements

### 2.1.3 Power Budget

## 2.2 Proposal Product

### 2.2.1 Mower

### 2.2.2 Docking Station

### 2.2.3 Remote Control

## **2.1 Principles**

The principles we are following in the creation of the Personal Automated Lawn Mower (P.A.L.M) product are aimed towards providing convenient method of mowing a lawn with minimal effort so that the owner(s) will have a well-maintained lawn without any extra effort or lawn care services.

Our mower will be able to create a cutting path anywhere there is an open sky above and be power independent. The system can be placed in the middle of an open field without any available power outlets and be able to cover a large field on its own.

The mower will also be able to detect obstacles in its path so that it may avoid them and cut around the object.

### **2.1.1 Block Diagram**

The block diagram defines the modules needed for the project and shows the flow of communication between the different modules. The block diagram will consist of three assemblies, the mower, docking station, and controller.

The mower module is the main module of this product, it will have two control systems, the mower control module to manage the mower functions and direction, as well as a GPS RTK module that will communicate with the docking stations RTK module for accurate positioning. The main source of power for this module will be a rechargeable solar power module.

The docking station module will be the mower's return to home location as well as the unit that provides real time GPS corrections via the GPS RTK module. This will provide accuracy down to 3 cm and allow for accurate pathing [4]. This station will be powered by a rechargeable solar power module.

The controller will be a simple handheld Bluetooth controller that allows the user to direct the mower for programming GPS coordinates and adding extra mower paths for fine tuning.

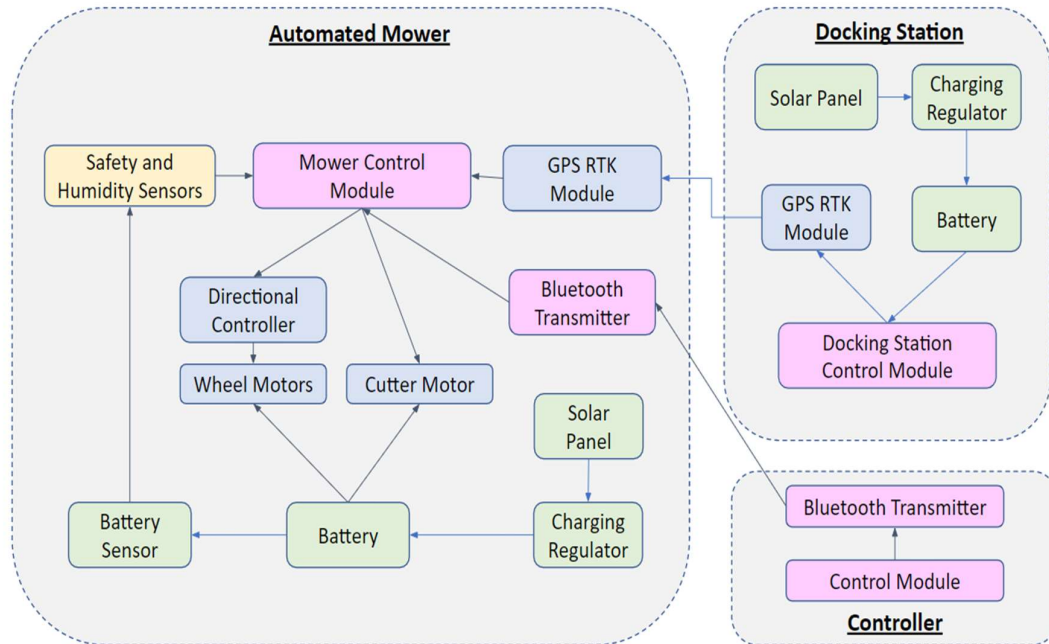

Figure 2.1 P.A.L.M. Block Diagram

## 2.1.2 Engineering Requirements and Specifications

In order to confirm the product is a success, the P.A.L.M. shall meet the following Design Engineering Requirements (DER) as shown in Table 2.1 below.

These requirements are separated into high, medium, and low level requirements and are ranked on importance level for the desired function of the product. We will need at minimum all high level requirements to be fulfilled for the P.A.L.M. to function at the bare minimum design requirements and function properly.

The medium level requirements are additional features that we would like implemented in the design to supplement the high level features and provide the product with additional desirable functions that the intended consumers may find useful.

The low level requirements are bonus features to further enhance the overall product and create a more desirable overall product.

Table 2.1 Design Engineering Requirements (DER)

<b>Design Engineering Requirements</b>		
<b>Level</b>	<b>Requirements</b>	<b>Verifications and Success Criteria Tests/Trials</b>
<b>High</b>	<ol style="list-style-type: none"> <li>1. The user shall be able to teach the mower which sections of the lawn to mow.</li> <li>2. The mower shall be able to successfully mow a predetermined section of the lawn without further help from the user.</li> <li>3. The mower shall actively charge by using the attached solar panel to extend battery life.</li> <li>4. The mower shall be able to return to the docking station once it has done mowing.</li> </ol>	<ul style="list-style-type: none"> <li>● The controller interface will verify and display lawn borders.</li> <li>● Once the lawn borders are created and paths created, mower will follow a predetermined path.</li> <li>● Microcontroller will monitor the battery source and pause mowing when power levels are too low.</li> <li>● Once the mower has completed cutting or needs to stop, it will return to the docking station.</li> </ul>
<b>Mid</b>	<ol style="list-style-type: none"> <li>1. The mower shall be able to automatically avoid obstacles in the yard using sensors.</li> <li>2. The mower shall remember the mowing path for future use.</li> </ol>	<ul style="list-style-type: none"> <li>● The mower will utilize sensors and move around the object(s) in its path.</li> <li>● The mower will follow the same repeatable path each iteration.</li> </ul>
<b>Low</b>	<ol style="list-style-type: none"> <li>1. The mowers power source shall provide at least 45 minutes of continuous mow time.</li> </ol>	<ul style="list-style-type: none"> <li>● Battery tests will be performed both in direct sunlight and in the shade to determine potential battery life.</li> </ul>

The P.A.L.M. provides automatic maintenance of the user’s lawn with the only contact required being the initial setup of the mower. The engineering specifications table shows the project’s requirements and product specifications. These specifications ensure ease of use for the user as well as an automatically recharging and deploying system to ensure the lawn is constantly being maintained.

Table 2.2 Design Engineering Specifications (DES)

<b>Mower</b>				
<b>Part</b>	<b>Specific Component</b>	<b>Engineering Specification</b>	<b>Justification &amp; Verification</b>	<b>Responsibility</b>
Microcontroller	Raspberry Pi 4	<p>Must be able run off a 12V DC power source.</p> <p>Controls motor and directional controls to determine where to move and what is left to cut.</p> <p>Must be able to detect at least 3 safety and detection sensors.</p> <p>Must be able to use a GPS and compass antennas to determine global position.</p>	<p><b>Justification:</b> Needs to be able to apply custom code and respond to GPS, sensor, and pre-mapped paths. Controller also must be able to monitor speed, direction, and cutter speeds.</p> <p><b>Verification:</b> Controller will verify GPS and sensors are active. If a pre-mapped path is not created a new path will be generated by the code or user input.</p>	Gabriel

Car Kit	Robot Smart Car Chassis by XiaoR	<p>Must be able to support the weight of solar charging kit, batteries, motors, and electronics.</p> <p>Must have enough room to hold all components and allow the cutter to move freely.</p> <p>Must be able to traverse multiple terrains and ground conditions.</p>	<p><b>Justification:</b> The frame is capable of carrying the solar panel on top, batteries and electronics within, and cutter mower on the bottom.</p> <p><b>Verification:</b> Aluminium construction frame and metal track gears will be able to support the weight.</p>	Group
Solar Panels	TBD	<p>Must be able to charge batteries both while docked and while the mower is moving.</p> <p>Must be able to charge a 12V battery source.</p> <p>Must weigh less than 1 kg</p>	<p><b>Justification:</b> Battery must be able to be recharged within 8 hours of direct sunlight.</p> <p><b>Verification:</b> Solar Panel test will be checked before installation and microcontroller will verify battery charge before use.</p>	Group
Blades	TBD	<p>Must be lightweight and easily replaced.</p> <p>Must be able to cut grass efficiently.</p>	<p><b>Justification:</b> The cutter blades must not tax the cutter motor and can be easily replaced if damaged.</p> <p><b>Verification:</b> A test run of the motor will be run to verify that the cutter mower is not experiencing high current drain.</p>	Brian



Battery	ML9-12 - 12 V 9 Ah Rechargeable SLA Battery - Mighty Max	<p>Must be able to fit in the designated assembly frame.</p> <p>Must be able to provide 9V power to motors.</p> <p>Must be able to provide at least 45 minutes of run time.</p>	<p><b>Justification:</b> Battery pack must fit within the allotted space on the unit and be able to provide more than the required voltage and current. Battery must be able to power the unit for at least 45 minutes at a time.</p> <p><b>Verification:</b> Microcontroller will have a voltage test code program to verify that the battery voltage is within 95% of the stated voltage (12 V).</p>	Brian
Object Detection Sensor	TBD	<p>Must be sealed to the environment.</p> <p>Must be passive and not have excessive drain on batteries.</p>	<p><b>Justification:</b> Sensors will close a signal loop and notify the microcontroller that an object is in the mowers path.</p> <p><b>Verification:</b> sensors will be tested and verified that they are in working order.</p>	Gabriel

Blade Motor	775 Motor	<p>Must be able to spin cutter blades at 2000 rpm minimum.</p> <p>Must be durable and resilient enough to take impact.</p> <p>Must be able to run on a 12V DC source.</p>	<p><b>Justification:</b> Most commercial lawn mower blades spin at 3000 rpm, but grass can still be cut with a 2000 rpm motor. This will allow for better power efficiency and still allow the blades to cut through most grasses and weeds.</p> <p><b>Verification:</b> Upon startup, the mower will turn on the cutter mower while docked and verify current drain is within specifications without a load.</p>	Brian
GPS	U-Blox ZED F9P	<p>Must have RTK base station and Rover communication capability.</p> <p>Must be able to communicate with multiple satellites and proved real time corrections for accurate pathing.</p> <p>Must have at least 3cm of positional accuracy.</p>	<p><b>Justification:</b> Since the mower will be GPS driven, accurate positioning will be required to be at least 5% of the overall cutting area.</p> <p><b>Verification:</b> Upon startup, the mower will calculate and send real time adjustments between mower GPS unit, Docking Station GPS unit, and satellites.</p>	Group

<b>Docking Station</b>				
<b>Part</b>	<b>Specific component</b>	<b>Engineering Specification</b>	<b>Justification &amp; Verification</b>	<b>Responsibility</b>
Solar Panel Kit	TBD	<p>Must be able to charge batteries while the system is running.</p> <p>Must be able to charge a 12V battery source.</p>	<p><b>Justification:</b> Docking station will have vital electronics necessary to provide real time corrections for GPS accuracy.</p> <p><b>Verification:</b> Charging system will have a voltage controller that will display the supplied voltage and voltage of the battery.</p>	Brian
Microcontroller	Raspberry Pi 3	<p>Must be able to charge batteries while the system is running.</p> <p>Must be able to charge a 12V battery source.</p>	<p><b>Justification:</b> Needs to be able to run RTK GPS systems for real time corrections for mower.</p> <p><b>Verification:</b> Controller will verify GPS and sensors are active.</p>	Gabriel

GPS	U-Blox ZED F9P	<p>Must have RTK base station and Rover communication capability</p> <p>Must be able to communicate with multiple satellites and proved real time corrections for accurate pathing</p> <p>Must have at least 3cm of positional accuracy.</p>	<p><b>Justification:</b> Since the mower will be GPS driven, accurate positioning will be required to be at least 5% of the overall cutting area.</p> <p><b>Verification:</b> Upon startup, the mower will calculate and send real time adjustments between mower GPS unit, Docking Station GPS unit, and satellites.</p>	Brian
Controller				
Part	Specific component	Engineering Specification	Justification & Verification	Responsibility
Bluetooth Controller	TBD	<p>Must be able to communicate with the microcontroller on the mower for programming and directional controls</p> <p>Must be able to provide real time controls for fine tuning programs</p>	<p><b>Justification:</b> Controller will allow the user to program and give fine tuning to the cutting path.</p> <p><b>Verification:</b> When the mower is set to program mode, the mower and controller will connect.</p>	Gabriel

### 2.1.3 Power Budget

The Power Budget is used to show how much power is being consumed for each device and allows us to verify that there is enough power supplied to run the devices.

Table 2.3 Power Budget

<b>Mower</b>						
<b>Part</b>	<b>Description</b>	<b>Qty</b>	<b>Current (A)</b>	<b>Voltage (V)</b>	<b>Power (W)</b>	<b>Extended Power (W)</b>
Control Module	Raspberry Pi	1	3.00	5.10	15.30	15.30
Drive Motor	Robot Smart Car Motor	2	1.20	9.00	10.80	21.60
Cutter Motor	775 Motor	1	10.00	12.00	120.00	120.00
Radio Antenna	XBee X2C	1	4.00E-02	3.30	0.13	0.13
GPS Module	simpleRTK2B	1	1.80E-01	3.30	0.60	0.60
humidity sensors	Gowoops DHT22 Sensor	1	2.50E-03	5.00	0.01	0.01
<b>Total Power (W)</b>						157.64

<b>Docking Station</b>						
<b>Part</b>	<b>Description</b>	<b>Qty</b>	<b>Current (A)</b>	<b>Voltage (V)</b>	<b>Power (W)</b>	<b>Extended Power (W)</b>
Control Module	Raspberry pi	1	3.00	5.10	15.30	15.30
Radio Antenna	XBee X2C	1	4.00E-02	3.30	0.13	0.13
GPS Module	simpleRTK2B	1	1.80E-01	3.30	0.60	0.60
<b>Total Power (W)</b>						16.03

## 2.2 Proposal Product

In order to create this product, we considered a wide range of different solutions, technologies, and approaches, and thoroughly researched each option to see what will best fit the product. The majority of the decisions made were made to allow the mower to be compact and lightweight, while allowing for a high degree of pathing accuracy. We will explain the three devices with more details on the key components used in each device.

### 2.2.1 Mower

The mower assembly will act as the mobile unit that will be used for cutting and maintaining a lawns grass height. The mower frame will be the carrier for all of the modules that will work as a complete module to automatically move along a designated path, cut the grass, and determine real time location with GPS.

The mower will be powered by a rechargeable 12.8V, 6Ah battery and actively recharged using a 10W solar panel. Mower pathing will be determined by a set of boundary waypoints determined by GPS coordinates and then automatically pick the best path to travel, ensuring the entire yard is cut. This unit will be actively communicating with a fixed position RTK GPS module to provide accurate positioning down to 3 cm.

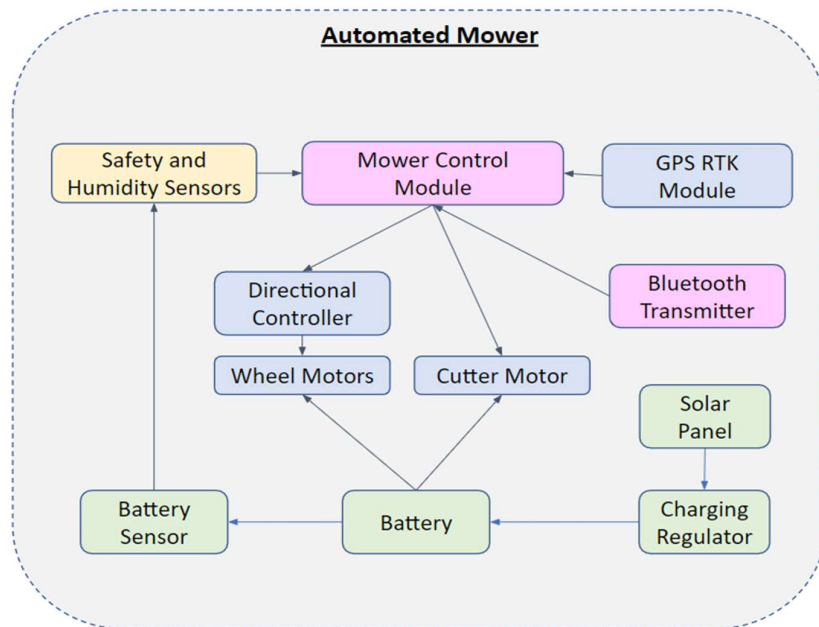

Figure 2.2 Mower Block Diagram

### 2.2.1.1 Mower Chassis Assembly

The mower chassis assembly will be designed with modules installed in three sections for installation:

The bottom layer will house the drive motors, stepper motor controllers, drive tracks, cutter motor, cutter blade, and power source as shown in the CAD drawing made with Fusion 360 in Figure 2.3 below.

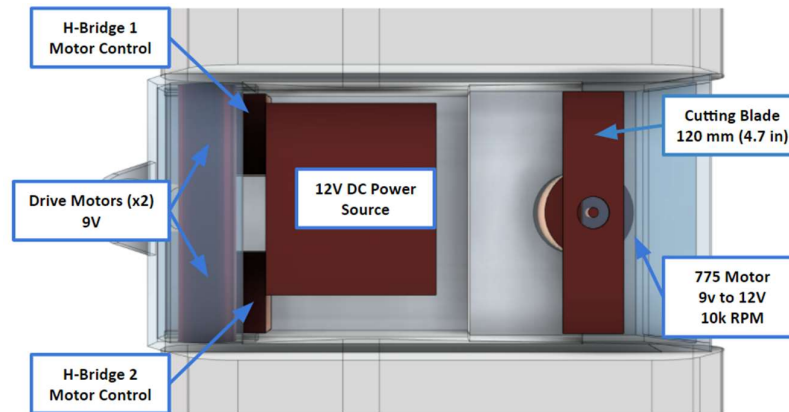

Figure 2.3 Mower Chassis Assembly Bottom

The Middle layer will house the majority of the electronic devices within a sealed box. In this section, the microcontroller, voltage regulators, and solar charging regulator will be housed as shown in Figure 2.4 below.

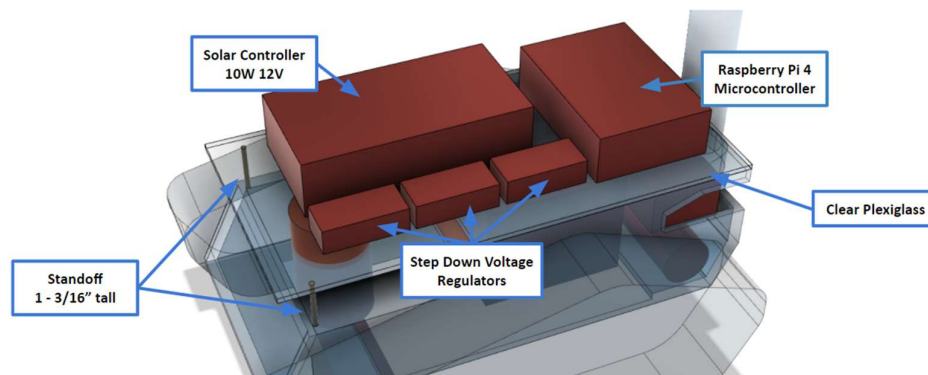

Figure 2.4 Mower Chassis Assembly Middle

The top layer will house the GPS communication module, compass, and solar panel as shown in Figure 2.5 below.

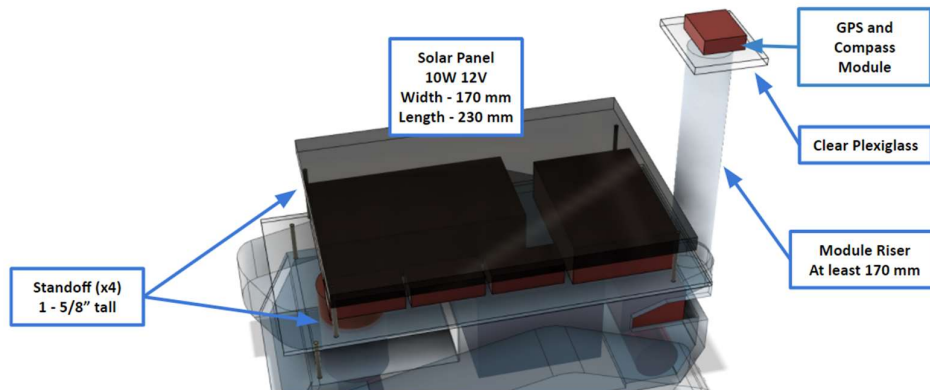

Figure 2.5 Mower Chassis Assembly Top

The reasoning behind this chassis was to find the best possible all-terrain vehicle that could easily move on a wide variety of ground conditions, be able to move over bumpy ground with ease, and is capable of climbing up an incline, all while being able to hold and transport all of the components needed for the mower to function properly.

By using the XiaoR Smart Car Chassis, we were able to make use of an all-terrain vehicle with tank-like treads that has an aluminium chassis, can climb inclines up to 30 degrees, and allows for a 7kg weight capacity. In addition, the chassis is also modular so we can easily add on components and modify the chassis to fit our needs.

### 2.2.1.2 Motors

There will be two different types of motors used in this assembly, brushless motors used as the drive motors and a brushed motor used as the cutter mower. The brushless motors are used to drive the mower as they provide more power for the size and are perfect for propulsion. However, we will be using a heavy duty brushed motor with ball bearings for the cutter motor as the motor is expected to hit an object and repeated impacts could damage a regular motor.

### 2.2.1.3 Power and Solar Charging System

In order to make the mower completely self-reliant, we wanted to allow it to create its own power without outside intervention. The charging system will use a 10W solar panel, a 12V solar charger controller, and a rechargeable 12.8V battery. This system will



allow the battery to recharge during the daylight and maintain a steady flow of power back to the system to keep the battery charged while the system is running.

#### **2.2.1.4 GPS RTK System - simpleRTK2B**

The heart of the pathing system will revolve around the GPS modules both on the mower itself and the docking station. Ordinary GPS modules will typically only have a positional accuracy between 1.5m and 3m, which is well beyond the threshold of accuracy needed for this product. In order to increase the positioning accuracy within the threshold needed by this system, we needed to use a GPS module with Real Time Kinematics (RTK) capability [5]. This will allow our mower to achieve between 1cm and 3cm of positional accuracy, which is exactly what this product will require.

How an RTK capable GPS module works is that the GPS module being tracked will not only communicate with the satellites in the sky but an additional transponder station, either a GNSS tower or an additional RTK capable GPS unit that is acting as a broadcasting tower will work. The stationary tower that is broadcasting will provide real time corrections based upon its stationary location to the mobile GPS unit, allowing for centimetre level accuracy.

For this product, we will be using a secondary RTK capable GPS unit housed in the docking station to allow the product to be used outside the range of cell phone towers.

#### **2.2.1.5 Microcontroller - Raspberry Pi 4**

In order to control all the motors, sensors, and pathing capabilities, we will be using a Raspberry Pi 4. It has a large selection of input and output pins available to control various functions and does not require a large amount of power to operate.

### **2.2.2 Docking Station**

The stationary docking station will be essential for providing accurate positioning data via the RTK capable GPS module and provide the mower a place to return to home when it has completed cutting its designated path. This station will be completely self-reliant and use a rechargeable battery powered by a solar panel.

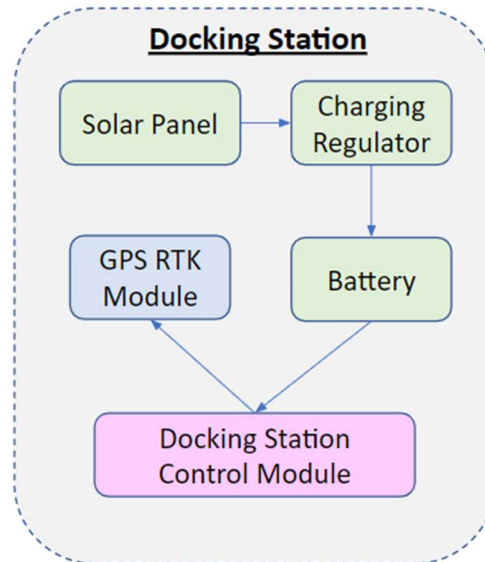

Figure 2.6 Docking Station Flow Chart

This system will be simple in design and its primary purpose is to provide real time positioning corrections to the mower.

### 2.2.2.1 Microcontroller - Raspberry Pi 3

Since this system will be simple in design, the unit will be controlled by a single Raspberry Pi 3 and will be responsible for controlling the RTK capable GPS module and monitor the power levels of the solar recharging system.

### 2.2.2.2 Power and Solar Charging System

The Docking Station will be the primary system that allows for accurate pathing for the mower module. Since the docking station will be stationery and weight will not be a limitation, it will use a larger 12V rechargeable battery than the mower, but still utilize the same 10W solar panel and solar charging controller as the mower.

### 2.2.2.3 GPS RTK system - simpleRTK2B

In order to transmit real time positioning corrections to the mower, the Docking Station will have an RTK capable GPS module configured as a base station. Because this system will be immobile, it will be able to use its exact location to provide centimetre level

accuracy to the mower, allowing it to accurately follow a path without variance outside the acceptable tolerance level.

### **2.2.3 Remote Control**

In order to program the mower with the correct coordinates and provide the user an option for fine tuning the path and directly controlling the mower. This will be an application designed to be used on any smartphone and will connect to the mower or docking station via Bluetooth connectivity.

# Chapter 3

## Non Technical issues

### Summary

This chapter goes over the budget and timeline of the project, as well as several aspects of the mower including environmental aspects, safety aspects, ethical aspects, social aspects, and sustainability of the project.

- 3.1 Budget and Timeline**
- 3.2 Environmental Aspects**
- 3.3 Health and Safety**
- 3.4 Ethical Aspects**
- 3.5 Social Aspects**
- 3.6 Sustainability**

### 3.1 Budget and Timeline

Table 3.1 Budget

Description	Qty	Price	Total price
Raspberry pi 4	2	\$61.88	\$123.76
Car Kit	1	\$79.00	\$79.00
Solar Panels	2	\$25.99	\$51.98
Cutting Blade	1	\$5.68	\$5.68
Battery	2	\$21.99	\$43.98
Power Converter	2	\$14.99	\$29.98
Humidity Sensors	1	\$11.98	\$11.98
Push Button	2	\$7.99	\$15.98
3D Printed Parts	3	\$10.00	\$30.00
Blade Motor	1	\$29.95	\$29.95
RTK Modules	2	\$325.00	\$650.00
GPS Module	1	\$18.59	\$18.59
<b>Total</b>	<b>20</b>	<b>\$613.04</b>	<b>\$1,100.04</b>

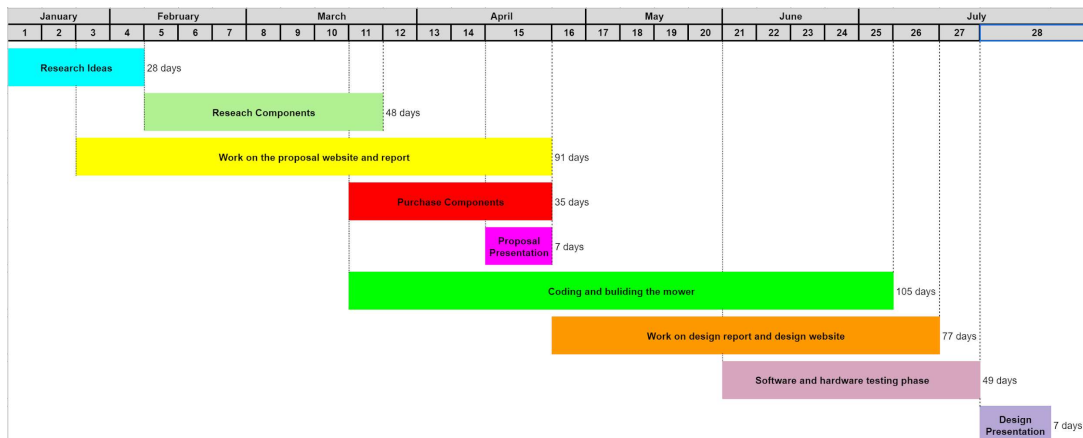

Figure 3.1 Timeline

### 3.2 Environmental Aspects

The mower runs on a large battery which if disposed of incorrectly could be hazardous to the environment. Over time if the contents of the battery were to leak it could cause damage to water supplies or to the soil. Another important factor is that many of the components of the mower are constructed with plastic which does not deteriorate easily

over time, in order to prevent environmental pollution, it is recommended that these plastics be recycled or disposed of appropriately. However, the mower does help the environment on a small scale by maintaining the grass healthy due to regular mowing and by avoiding the build-up of pests in urban areas.

### **3.3 Health and Safety**

In order to mow the grass, the mower requires a sharp blade rotating at a high speed. Because of its sharpness this blade could cause bodily harm if the mower were to be misused. To combat this the mower was designed with a shield surrounding the blade, the shield prevents anything from slipping under the blade while the mower is active. In addition to this it was decided that obstacle sensors would be another effective safety feature. This sensor would not only help avoid injury by steering the mower away from any non-grass object but would also protect the blade itself from being damaged against something it wasn't meant to cut.

Because the blade needs to be rotated at a high speed it was necessary to acquire an adequately powerful battery. The power budget table shows how all the electric components do not surpass the max capacity of the battery. Surpassing the max capacity of the battery could lead to electrical failures as well as burning and even fires in extreme scenarios. It is recommended that the lawn be as debris free as possible in order to avoid unnecessary risks. This device should never be operated by children and should not be allowed near pets.

### **3.4 Ethical Aspects**

The ethical goals of this project are to give an effortless way to mow the lawn to those who are physically incapable of doing so including the elderly and the differently abled, and to help avoid pests and the diseases they might bring. Having pests puts the individual at risk of contracting different diseases they might carry, and this also applies to anyone living nearby who could be affected by these pests. This also helps improve the look of the neighbourhood since nobody wants to live next to the neighbour who ignores his lawn.

### **3.5 Social Aspects**

The social goal of this project is to provide people with a reliable and efficient way to mow their lawn while taking away most if not all the effort typically involved in doing so. This project does not only help people searching for a simple quality of life improvement, but it also helps those who are unable to perform this strenuous physical activity. Having a regularly mowed lawn also helps avoid pests as well as the issues that they bring. Regular mowing is also known to help keep grass healthier and to keep weeds at bay.

### **3.6 Sustainability**

The mower is expected to last at least one hour on a single charge, but because the mower is constantly charging via the solar panel this number can vary depending on the exposure to sunlight. It is recommended that the mower be cleaned from time to time to combat wear and tear, and it is not recommended that the mower operate in high humidity conditions. The mower does come equipped with a humidity sensor so that the device knows when conditions are ideal.

# Chapter 4

## Conclusion

### Summary

This chapter discusses the summary and conclusion for the mower project as well as the suggestions for future work which could further improve the project based from our research.

#### **4.1 Summary and Conclusion**

#### **4.2 Suggestions for Future Work**



## 4.1 Summary and Conclusion

The P.A.L.M. mower is a project designed in order to help remove the inconvenience of having to constantly mow the lawn. This project would especially help both the elderly and the differently abled who lack the physical capabilities to mow their own lawn. The mower is designed with the capability to learn the shape of your lawn and cut it in the quickest and most efficient way possible while avoiding obstacles. This efficient cutting method not only helps conserve battery life but it also helps avoid wear and tear on the unit itself.

The mower is expected to last at least one hour with a full battery, this can be extended depending on the level of sunlight during the operation of the mower. During the initial setup the mower will be steered by a controller, this will be used to move it to the four border points of your lawn assuming the lawn has a rectangular shape. At each of these four border points a button on the controller will be pressed to indicate to the mower that it should record the GPS coordinates of that point. From here the mower will use the four points in order to calculate the best path to follow to mow the lawn efficiently.

Once the four points have been saved the mower will use the top left point as the starting point and move downwards towards the bottom left point. From here the mower will return to the top left point and now move to the right a distance equivalent to the width of the mower. Next the mower will begin moving downwards again until it reaches the level of the bottom starting point and then return back up. This process will be repeated until the mower reaches the right most starting point and mows the final section of the lawn. Once it has finished the mower will stop and begin to recharge to prepare for the next mowing which will be determined by the user during setup. The mower's components include a Raspberry Pi, a solar panel, a mower blade, a 12 volt battery, a humidity sensor, a GPS and compass module, and an RTK module.

In order to complete this project the team had to take into account the environmental aspects of the mower as well as the health and safety issues of its design. The main concerns were having a fire hazard due to overworking the battery and the risk of injury due to the mower's blade. In order to avoid a fire all the components had to be within the operational limits of the battery, all the components were selected to avoid reaching this limit as can be seen in the power budget table. In order to mitigate the risk of injury, the blade was encased in a shield which would prevent it from cutting anyone

accidentally and the mower was equipped with obstacle sensors to avoid anything that wasn't supposed to be cut in the first place.

## **4.2 Suggestions for Future Work**

This section will be determined in the Project Development phase.

# References

- [1] “Getting Started With Mowbot”, MowBot.com [Online]. Available at: <https://www.mowbot.com/how-does-it-work/> [Accessed: 05/Feb/2021].
- [2] “Automower Models”, Husqvarna.com [Online]. Available at: <https://www.husqvarna.com/ca-en/products/robotic-lawn-mowers/models/> [Accessed 05/Feb/2021].
- [3] “MowRo - Easy, Safe, Fully Autonomous Lawn Mower”, indiegogo.com [Online]. Available at: [https://www.indiegogo.com/projects/mowro-easy-safe-fully-autonomous-lawn-mower#](https://www.indiegogo.com/projects/mowro-easy-safe-fully-autonomous-lawn-mower#/) [Accessed 05/Feb/2021].
- [4] “simpleRTK2B: the first multiband RTK shield based on ZED-F9P”, ArduSimple [Online]. Available at: <https://www.kickstarter.com/projects/simplertk2b/simplertk2b-the-first-multiband-rtk-shield-based-o> [Accessed 20/Mar/2021].
- [5] “What is GPS RTK?”, Nathan Seidle, [Online] Available at: <https://learn.sparkfun.com/tutorials/what-is-gps-rtk/all> [Accessed 20/Mar/2021].

# Appendix A

## Equations

Formula for Electric Power:

$$P = V * I \quad (A.1)$$

# Biography



## **Brian Darling**

- Planning to graduate from Valencia College July 2021
- B.S. in Electrical and Computer Engineering Tech, Electronics Systems Concentration
- A.S. in Electrical Engineering Tech, Electronics Concentration
- A.S. in Electrical Engineering Tech, Lasers and Photonics Concentration
- Experienced Manufacturing Engineer for PCBAs and electronic assemblies
- Experienced Process Description Writer for PCBAs and electronic assemblies



## **Gabriel De La Torre**

- Planning to graduate from Valencia College July 2021
- B.S. in Electrical and Computer Engineering Tech, Computer Systems Concentration
- A.S. in Electrical Engineering Tech, Electronics Concentration